

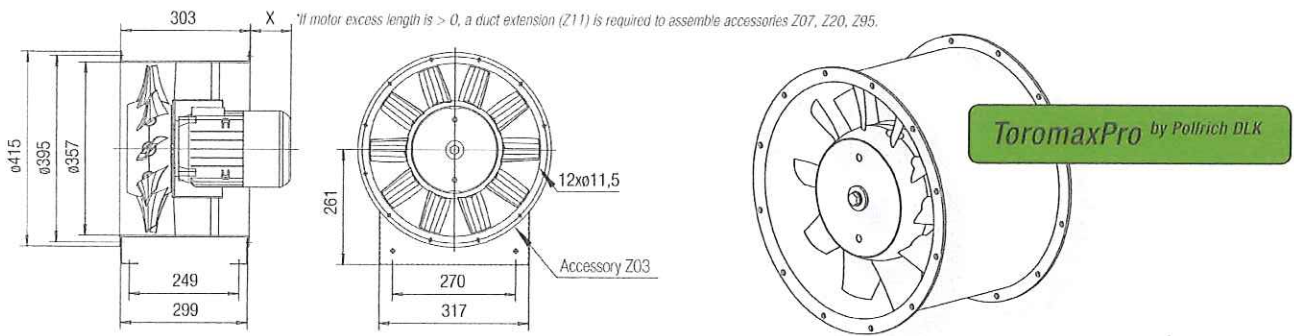

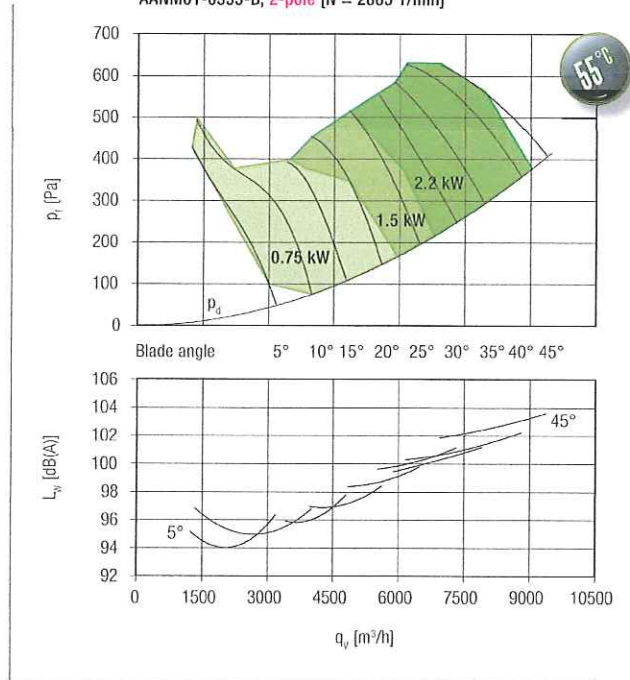

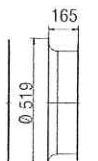

Ø 355 mm, Medium pressure axial fan AANM with outlet guide vanes

AANM01-0355-B, 2-pole [N = 2885 1/min]

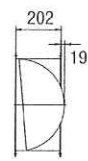
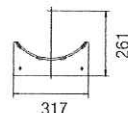

- 
Z04 Inlet nozzle with protective guard
 Ord. no. B202458
- 
Z07 Protective guard (motor side)
 Ord. no. B151075
- 
Z08 Counter flange
 Ord. no. B151021
- 
Z10 Flexible sleeve
 Ord. no. B141029
- 
Z11 Duct extension long
 Ord. no. B150968
- 
Z20 Automatic shutter
 Ord. no. B164199
- 
Z03 Mounting foot
 Ord. no. B151005
- 
Z16 Rubber anti-vibration mounts (see below)
- 
Z56 Terminal box (see below)

Full specifications for accessories, see page 76

AANM01-0355-B



No. of poles	Motor power output [kW]	Order no. Fan	Speed [1/min]	Voltage [V] Connection	Nominal current [A]	Starting current [A]	Motor excess length [mm] X*	Weight ca. [kg]	Order no. Z16	Order no. Z56
2	0.75	B214649	2850	400 Y	1.7	11.6	70	25	B266088	B223917
2	1.5	B214651	2880	400 Y	3.2	24.3	90	31	B266088	B223917
2	2.2	B214653	2880	400 Y	4.5	35.1	120	35	B266088	B223917
2/4	0.75/0.17	B214641	2845/1310	400 YY/Y	1.8/0.6	13.3/3.4	70	29	B266088	B150116
2/4	0.95/0.25	B214643	2835/1340	400 YY/Y	2.2/0.8	16.6/4.6	70	31	B266088	B150116
2/4	1.4/0.3	B214645	2850/1340	400 YY/Y	3.3/0.8	24.6/4.5	90	36	B266088	B150116
2/4	1.9/0.4	B214647	2850/1390	400 YY/Y	4.1/1	30.5/5.7	120	39	149894	B150116

When ordering, please indicate blade angle. Max. conveying temperature: 55 °C – higher conveying temperatures on request. All indicated values for 400V/50Hz/3-.. (60 Hz on request)